

MOBERN tenons and adapters are constructed of extruded aluminum and have a durable powder coat finish. The MITV/TH series brackets are for use with square & square tapered steel poles. The MITV series brackets are designed for use with the 2AF adjustable fitter or the MIP4024D slipfitter. The MITH series is designed for direct fixture mounting. The tenon portion of the mounting bracket measure 2-3/8" O.D.x 4" high.

Square Tenons

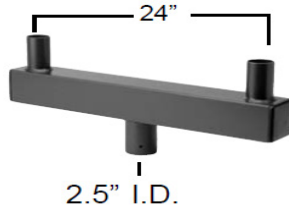

MITVA4
4" Base
MITVA5
5" Base
MITVA6
6" Base



MITV2
EPA 1.6

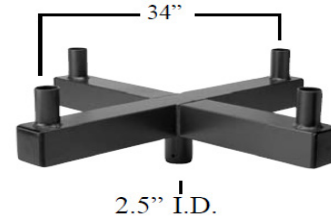

MITVC4
EPA 2.2

MITV3
EPA 2.6

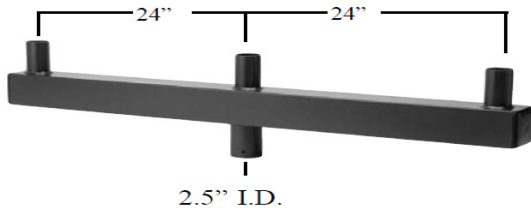

MITH2
EPA 2.6

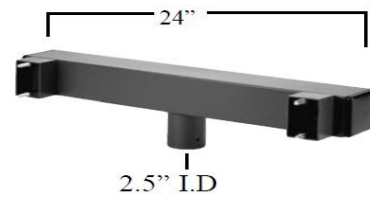

MITV4
EPA 3.6

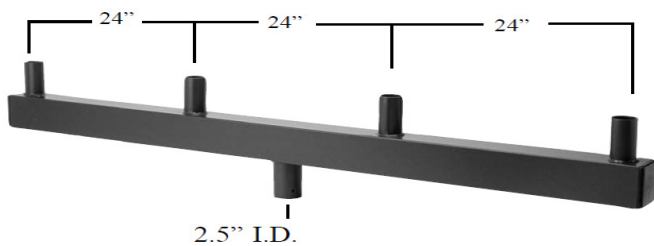

MITV3
EPA 2.6

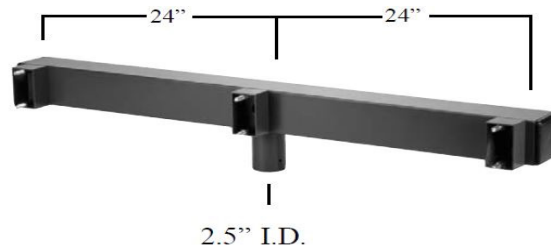

Adapters

M12AF
Adjustable
Knuckle
Fitter
EPA .5

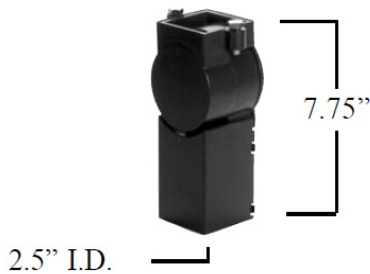

MIP4024D
Steel
Slipfitter
MIP4025D
WITH 1/2"
HUB

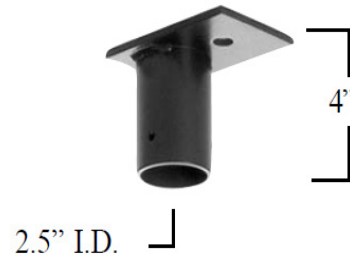

Dimensions and specifications subject to change without notice.

MOBERN tenons and adapters are constructed of extruded aluminum and have a durable powder coat finish. The MIRV series tenons are for use with straight round, and round tapered steel poles. This line of mounting brackets is designed for use with the MI2AF adjustable fitter or the MIP4024D slipfitter. The tenon portion of the mounting bracket measure 2-3/8" O.D.x 4" high.

Round Tenons

MIRV2
EPA .9

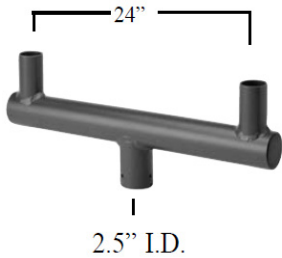

MIRV3120
EPA 2.2

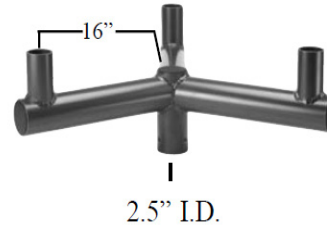

MIRV3
EPA 1.4

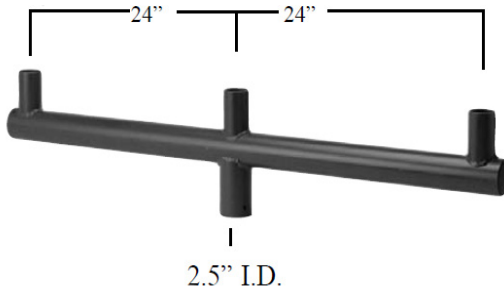

MIRVC4
EPA 2.2

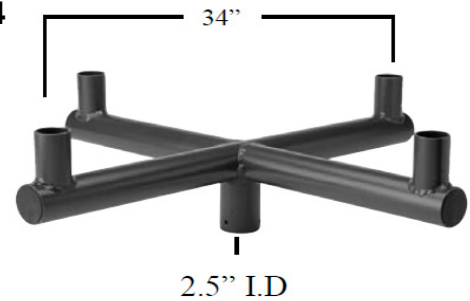

MIRV4
EPA 20

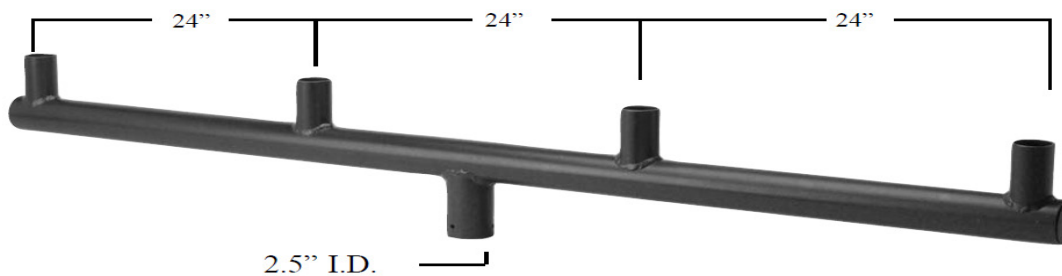

Adapters

MI2AF
Adjustable
Knuckle
Fitter
EPA .5

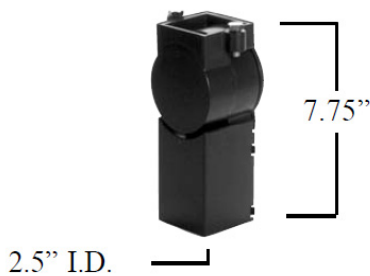

MIP4024D
Steel
Slipfitter
MIP4025D
WITH 1/2"
HUB



Dimensions and specifications subject to change without notice.

MOBERN tenons and adapters are constructed of extruded aluminum and have a durable powder coat finish. The MITH series tenons are for use with straight round, and round tapered steel poles. This line of mounting brackets is designed for use with the MI2AF adjustable fitter or the MIP4024D slipfitter. The tenon portion of the mounting bracket measure 2-3/8" O.D.x 4" high.

TH Round Tenons

MITH490*

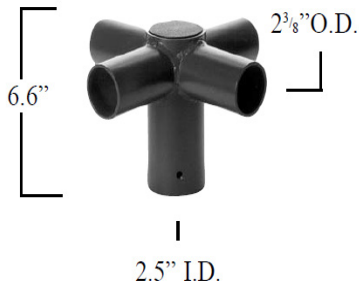

MITH2180

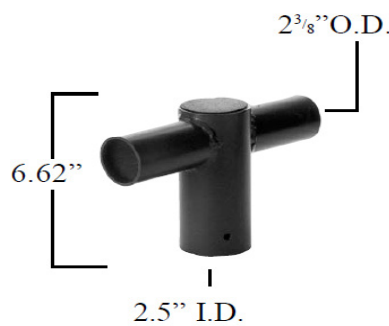

MITH290*

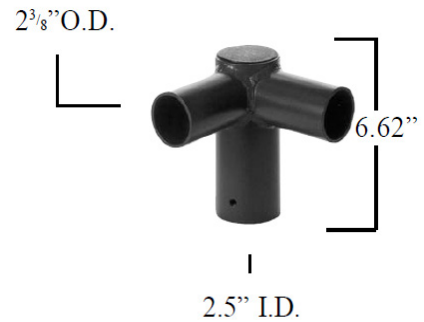

MITH3120*



MITH390*

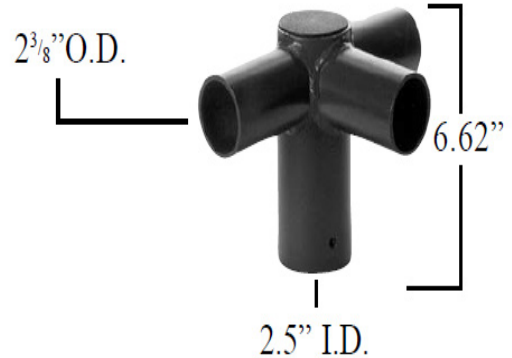

Adapters

MI2AF
Adjustable
Knuckle
Fitter
EPA .5

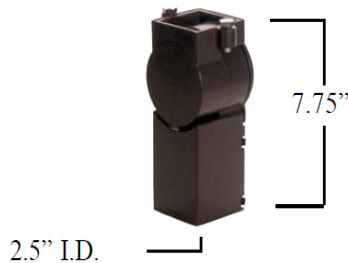

Mounting Specifications

For 12", 16" & 22" housing requiring MI2AF. Fixtures mounted to these brackets can be adjusted vertically.
NOTE: The MITH290, MITH490, MITH390 are for use with 12" & 16" housing only.
Other housing and arm configurations are available.
Please contact your Mobern Sales Representative for more information.

Dimensions and specifications subject to change without notice.

Adapters

Pole Top Adapter
(Steel) EPA .4
MIPTASSAVSA

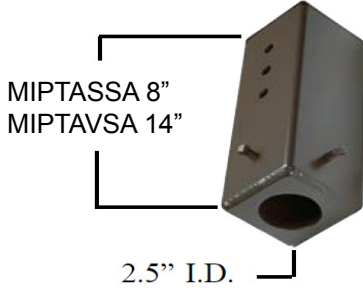

Standard tenon mount for straight arms

Mounting Arms
(Aluminum) EPA .3

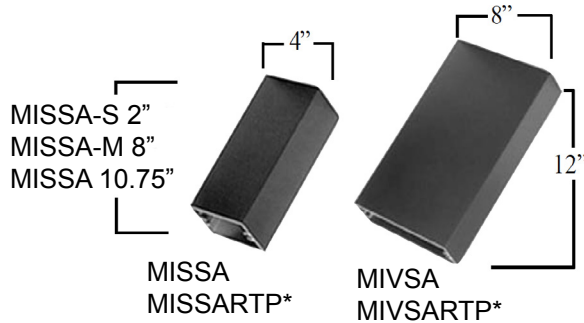

Use with MIFLT, MIPR, MIFTFLT and MICOFLT Series fixtures. For use with multiple units placed at 90° *MISSARTP, *MIVSARTP for round tapered poles.

MIPMH

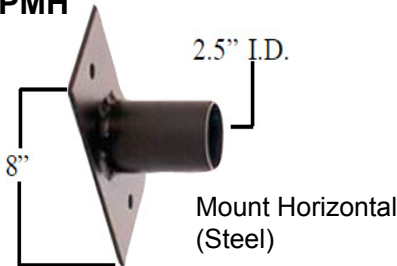

Mount Horizontal (Steel)
For pole mounting with MI2AF knuckle slip fitter.

MILFRWB

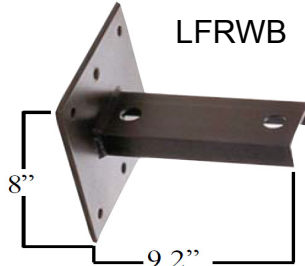

Wall Mount LRF
Direct mounting for large series floods.

MIWMSSA

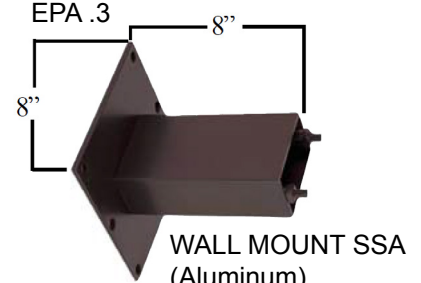

WALL MOUNT SSA (Aluminum)
Direct mounting for Flood and Roadway Parking Series

MIWMV



Wall Mount Vertical

MIWPB

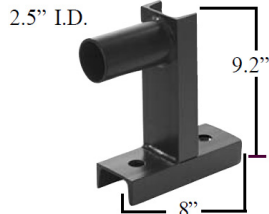

Wood Pole Bracket (Steel)
For wooden pole mounting with 2AF knuckle.

MIA41



Yoke Base (Steel)
For use with MIMD and MILG shoebox and flood fixtures.

MIWMH

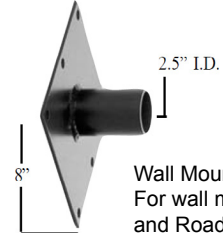

Wall Mount Horizontal (Steel)
For wall mounting with Flood and Roadway Parking Series fixtures. Mounting to be used with MI2AF knuckle slip fitter.

MIRTB1

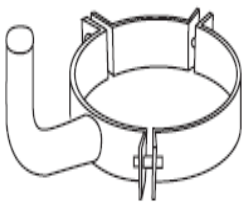

MIRTB2

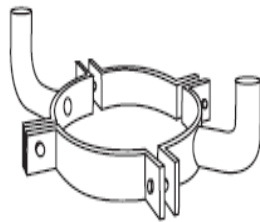

MIRTB3

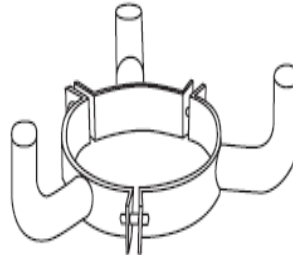

MIRTB4

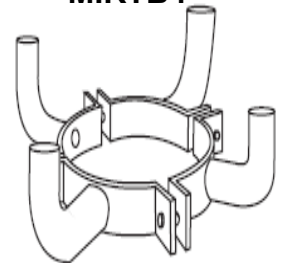

Dimensions and specifications subject to change without notice.