

ASD Installation Instructions

Overview



MOBERN
LIGHTING

WARNINGS

- This product must be installed in accordance with all applicable codes by a person familiar with the product.
- Each fixture must be **properly supported** during install.
- **DO NOT** join fixtures on the floor prior to lifting, or damage will occur.
- **Before beginning installation**, review our complete list of warnings by visiting www.mobern.com/warnings.

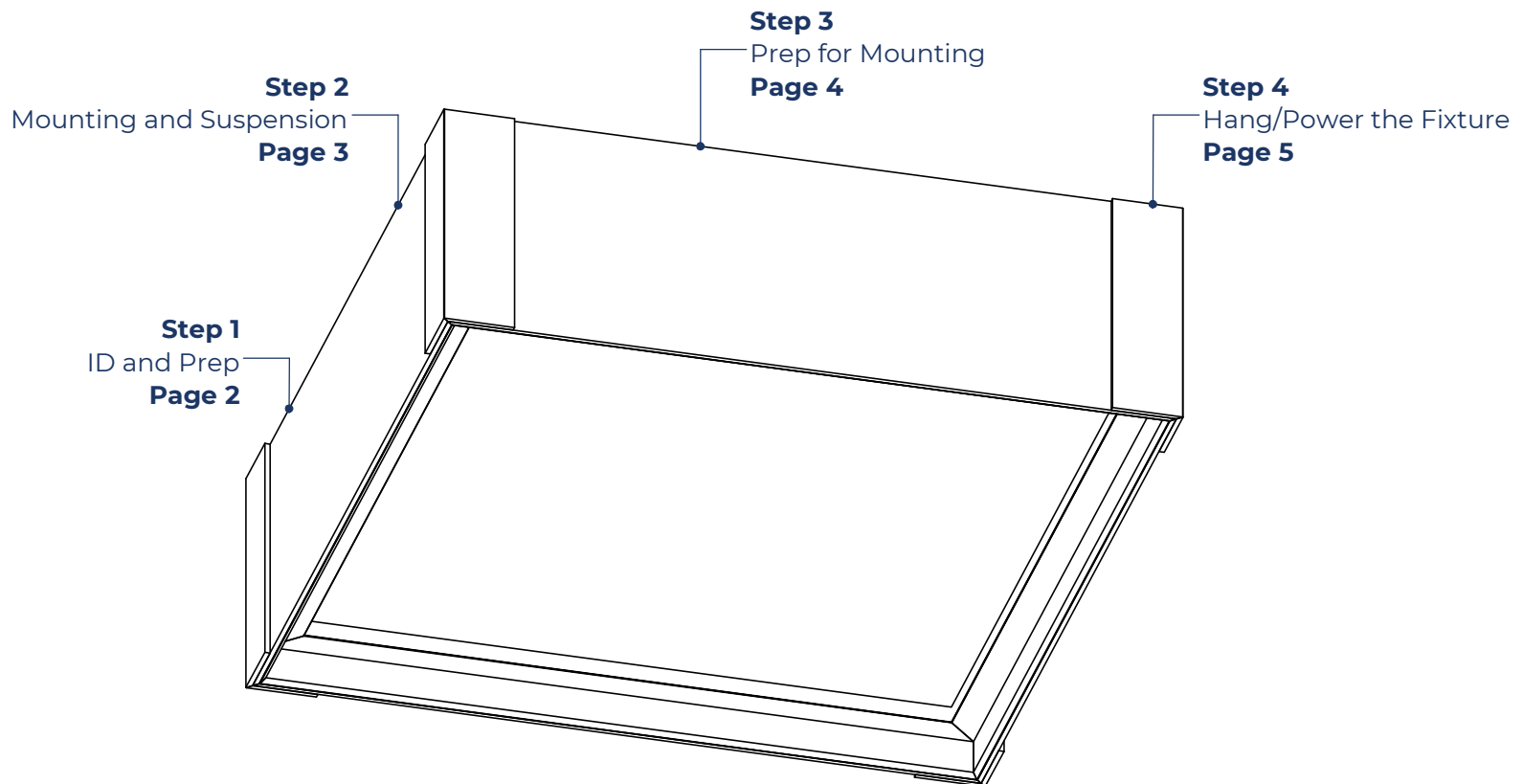

Form MCM - MOB-ASD, V1, 11/20

Your particular build may vary.

2020© Mobern Lighting Company | 8200 Stayton Dr., Suite 500, Jessup, MD 20794 | www.mobern.com

ASD Installation Instructions

Step 1 - Identification and Preparation



A. Identify Fixtures

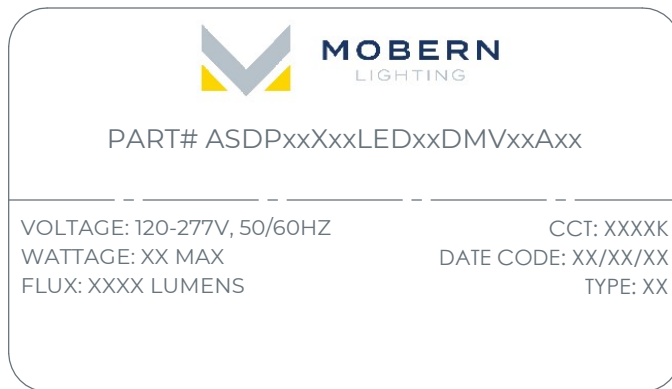

B. Tools Needed



Screwdriver



Pliers

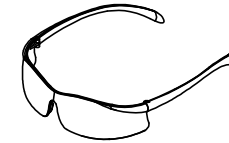

Safety Glasses

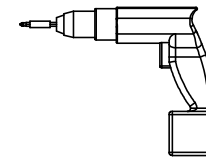

Drill

- Use labels found on the box and inside the fixture bodies to identify bodies.
- **NOTE:** Locations of labels can vary.
- Remove all fixtures from their boxes.
- Organize fixtures based on their labels at the install location.

- Always use proper safety equipment when installing fixtures.
- Tools shown are recommended for standard install. Tools needed may vary based on actual install location conditions.

Kitted Hardware

- Mobern has provided the items listed here, with their Saylite part numbers listed. These items can be found in separate boxes shipped with the fixture.
- Ensure all parts are accounted for and set them aside until needed.
- Any additional hardware needed for this installation will be provided by others.

ASD Installation Instructions

Step 2 - Mounting and Suspension



Mounting

Drywall or other hard surfaces - HC 801 (2x2) or HC 301 (4x4) Hanging Kit*

- Install hanging kits at suspension locations.
- Ensure hanging kits are secure.
- Prepare fixture for mounting.

Other hard surfaces include: wood, sheet metal panels, steel beams, concrete or masonry. Use hardware appropriate for each surface and material type.

Suspension Locations

X = Suspension Dimensions

Refer to Assembly Drawings and building plans to determine exact mounting, suspension points, and power feed locations.

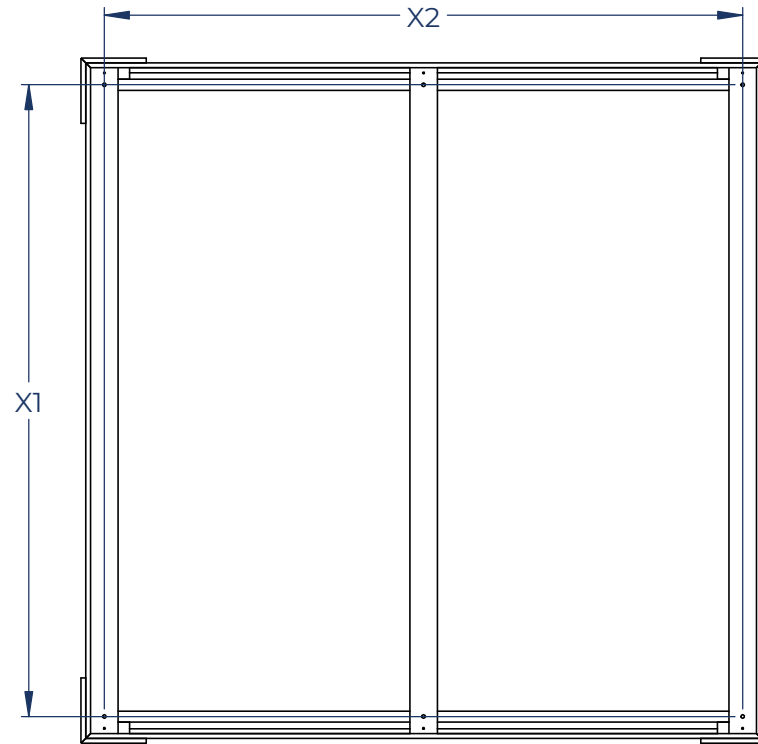

ASD Installation Instructions

Step 3 - Prepare Fixture for Mounting



A. Install Hanging Kits



- Install the hanging kits to the ceiling at the desired mounting locations.
- Ensure that hanging kits are properly secured.
- Adjust hanging cables to desired length, cables can be further adjusted after fixture is installed.
- Refer to hanging kit installation guide for more information.

B. Insert LED Fixture

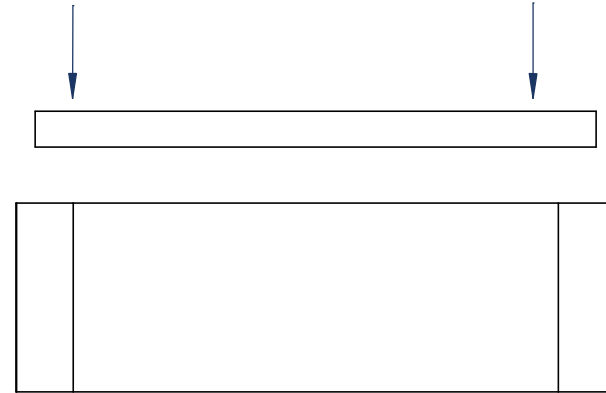

- Insert the LED fixture to the acoustic assembly.
- If needed, remove the wood supports from the acoustic assembly. Small pull out tabs are located near the center of each acoustic assembly side, pull the tabs down and remove the screws securing the wood supports.

ASD Installation Instructions

Step 4 - Hang and Power the Fixture



A. Hang the Fixture

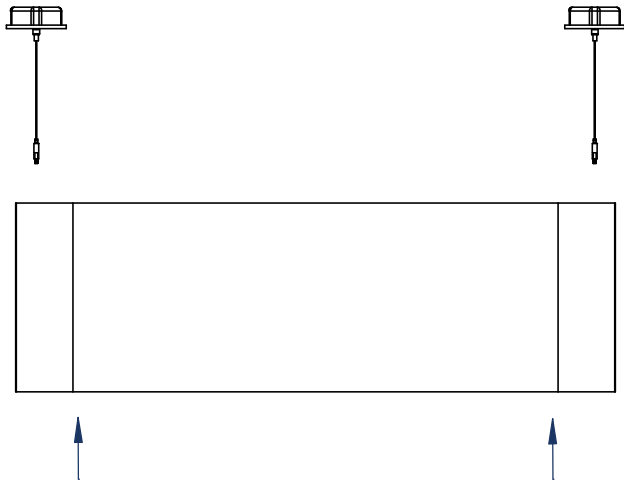

- For 2x2 fixtures: Hang the fixture by installing each of the hanging kits to the wood frame of the fixture.
- Screw the threaded end of the hanging cable into the pre-drilled holes on the frame.
- For 4x4 fixtures: Hang the fixture by installing each of the hanging kits to the hanging points in each corner of the fixture.
- Screw the threaded end of the hanging cable into the mounting holes of the fixtures. Secure using provided washer and nut.

B. Power the Fixture

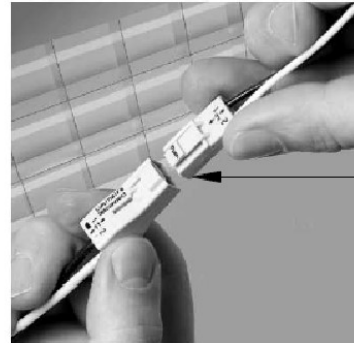

WIRING LEGEND		
BLACK	HOT	Line Voltage
WHITE	NEUTRAL	Line Voltage
GREEN	GROUND	
GRAY	DIMMING	0-10V DC
VIOLET	DIMMING	0-10V DC

- Wire fixtures to the incoming power supply using the provided quick disconnect clip as shown.
- For dimming option, refer to wiring legend above.
- Use UL approved connectors only. Follow all local, state and national codes.
- Installation is now complete.