

APPLICATIONS

A compact H.I.D. flood light ideal for sight, display, parking and general purpose security lighting.

FEATURES & BENEFITS

- ◆ High Pressure Sodium Lamps 250W - 400W (Mogul); Metal Halide lamps 175W - 400W (Mogul)
- ◆ Die cast aluminum housing with a bronze powder coat finish is standard. Consult factory for availability of other colors.
- ◆ Clear, tempered glass lens with high temperature silicone gasket for a watertight seal
- ◆ Trunion arm adapts to a wide variety of optional mounting brackets
- ◆ All Mobern floods are guaranteed for 1 year from any defects in materials and workmanship

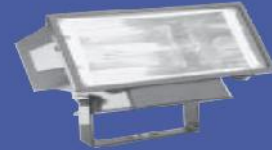

Metal Halide					
Part Number	Lamp Code	Color	Watts	Type/Volts	Lamp Description
MILGRFLT250MHPSQV	MH250U	Bronze	250	MH-MT	Mogul
MILGRFLT250MH480	MH250U	Bronze	250	MH-480	Mogul
MILGRFLT320MHPSQV	MH320U	Bronze	320	MH-MT	Mogul
MILGRFLT400MHPSQV	MH400U ED 28	Bronze	400	MH-MT	Mogul-ED28 CLR
MILGRFLT500MH480	MH400U ED 28	Bronze	400W 480V	MH-480	Mogul-ED28 CLR
High Pressure Sodium					
MILGRFLT250HPSQV	HPS250	Bronze	250	HPS-MT	Mogul
MILGRFLT250HPS480	HPS250	Bronze	250	HPS-480	Mogul
MILGRFLT400HPSQV	HPS400	Bronze	400	HPS-MT	Mogul
MILGRFLT400HPS480	HPS400	Bronze	400	HPS-480	Mogul

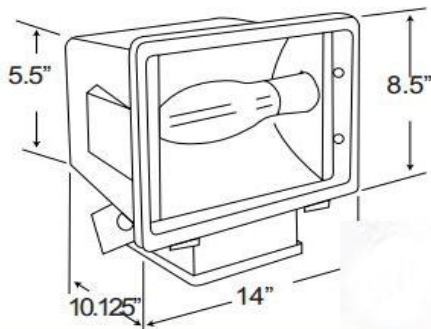

OPTIONS

MIP4024D

2 1/2" Bullhorn Slipfitter



MIWMV

Vertical Wall Bracket

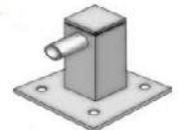

MILGRFWB

Wall Mount Bracket

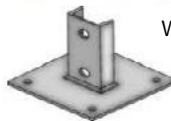

MIPMV

Pole Mount Bracket

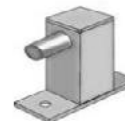

MIWPB

Wood Pole Bracket

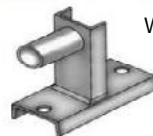

MILGRFLT Four Sided Shield
MIS-17 4 SIDED SHIELD

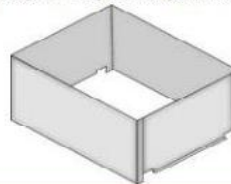

MILGRFLT Three Sided Shield
MIS-15 3 SIDED SHIELD

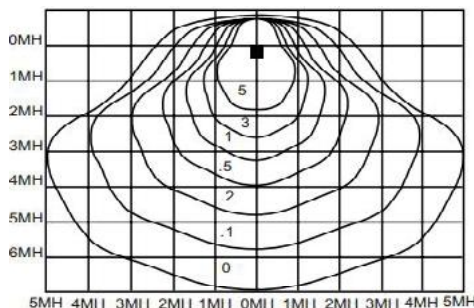

400 watts HPS unit with a clear unit at 10 ft. mounting height aimed at 30° below horizontal.