

APPLICATIONS

MDFH-VC8 8" aperture flat frame-in kits for (1) vertical CFL lamps. These are designed for use in non-insulated ceiling for general and task lighting. Heat sink aluminum socket housing, with vertically adjustable lamp holder may produce various focuses for different lamp types.

FEATURES & BENEFITS

Mounting Frame

- ◆ Galvanized steel construction.
- ◆ Housing adjusts for ceilings up to 1 - 1/4" thick.

Junction Box

- ◆ Listed for through branch circuit wiring. (Max.8 No 12 AWG 90°C branch circuit conductors. (4 in, 4 out)
- ◆ (5)1/2" knockouts with true pry-out slots and (4) knockouts with Romex cable clamp.
- ◆ Ground wire provided on J-box.

Reflector

- ◆ Anodized clear, haze, gold, champagne, pewter color finished full reflectors. And anodized reflectors with black or white milled groove baffle collar and glass Lens for shower trim.

Bar Hangers

- ◆ 24" Bar Hangers provide stability and support on joists and T-Bar Grid ceilings.
- ◆ Housing can be positioned at any point within 24" joist span.
- ◆ Score lines allow "toolless" shortening for 12" joists. Bar hangers may be repositioned 90 degrees.
- ◆ Integral T-bar clips snaps onto T-bars and no additional clips are required.

Trim Ring

- ◆ White plastic ring or plated chrome, stain nickel, natural steel color ring.

Socket

- ◆ G240Q/GX24Q socket for use 4 pin DTT, TTT lamps.

Socket Cap

- ◆ Heat sink aluminum cup with vertically adjustable lampholder is used to control multiple beam spreads.

Listing

- ◆ UL, c-UL listed for damp location.
- ◆ UL, c-UL listed for feed through.



Lamps

- ◆ Compact Fluorescent lamps.
 - * DTT-Double twin tube (Quad/CFQ)
 - (1) 13W DTT (4 pin)
 - (1) 18W DTT (4 pin)
 - (1) 26W DTT (4 pin)
 - * TTT-Triple Twin Tube (CFTR)
 - (1) 18W TTT (4 pin)
 - (1) 26W TTT (4 pin)
 - (1) 32W TTT (4 pin)
 - (1) 42W TTT (4 pin)
 - (1) 57W TTT (4 pin)
 - (1) 70W TTT (4 pin)

Ballast

- ◆ Class P Thermally protected by internal fuse (3 amp fast blow), Multi-volt electronic ballast or thermal cut-out switch in magnetic ballast.
- ◆ High Power Factor Multi-volt Electronic ballasts for 4 pin type compact fluorescent lamps mounted on J-box door for easy access from inside of fixture.

ORDERING DATA

EXAMPLE: MDFH-VC6132NE

MDFH-VC6							
Series	Lamps	Ballast		Options			
MDFH-VC8	113	(1) 13 W	NE	NPF Electronic	EM	Emergency w/Remote	
8" NON-IC Flat	118	(1) 18W		(For Use with 1/13W, 18W & 26W		Test Switch	
Frame in kit	126	(1) 26W		120V only)	Q	Quick Connectors	
	132	(1) 32W	HE	HPF Electronic (120/277)			
	142	(1) 42W	HEDM7	Mark 7 Dimming (120/277)			
	157	(1) 57W	HED1	Mark 10 Dimming (120V)			
	170	(1) 70W	HED2	Mark 10 Dimming (277V)			
			HELD1	Lutron Compact SE (120V)			
			HELD2	Lutron Compact SE (277V)			

*Other Dimming Products Available. Consult With Factory.
*1% Lutron Hi-Lume Limited Use For (1)26W & (1)32W TTT.

(For use with (1)13W, 18W & 26W 120V only)

• Just-A-Nail

Adjustable nail hanger bar for easy alignment.



JUST-A-NAIL

- Pre-installed nail bars with vertical slots are used to evenly align the bars horizontally after nailing halfway into wood joists.

• Optional "Quick Connect" Push-in wire connectors.

- Three "Quick Connectors"
- Pre-installed push-in wire connectors for fast wiring.

Dimensions and specifications subject to change without notice.















◆ 800-444-WATT ◆ www.mobern.com ◆
8200 Stayton Dr., Ste. 500, Jessup, MD 20794

CAT#

JOB NAME

TYPE

8" Vertical Compact Fluorescent Trims

<p>MDFT-V84 MDFT-V84SF (Self-Flanged) Specular Open Reflector 70W TTT White Plastic Trim Ring O.D. : 9-7/16" Height : 7-7/8"</p> 	 <p>MTFT-V84SM</p>	 <p>MTFT-V84GD</p>	 <p>MTFT-V84SF-SM</p>
<p>MTFT-V814 Baffle w/ Reflector 70W TTT White Plastic Trim Ring O.D. : 9-7/16" Height : 7-7/8"</p>	 <p>MTFT-V814WH</p>	 <p>MTFT-V814BK</p>	<p>MTFT-V836 Wall Wash w/ Kick-off Plate 70W TTT White Plastic Trim Ring O.D. : 9-7/16" Height : 7-7/8"</p>  <p>MTFT-V829SM</p>
<p>MTFT-V841 Baffle w/ Fresnel Lens 42W TTT White Plastic Trim Ring O.D. : 9-7/16" Height : 7-7/8"</p>	 <p>MTFT-V841WH</p>	 <p>MTFT-V841BK</p>	<p>MTFT-V822 Reflector w/ Fresnel Lens 42W TTT White Plastic Trim Ring O.D. : 9-7/16" Height : 7-7/8"</p>  <p>MTFT-V822CL</p>
<p>MTFT-V840 Reflector w/ Frosted Drop Lens 70W TTT White Metal Trim Ring O.D. : 9-7/16" Height : 7-7/8"</p>	 <p>MTFT-V840SM</p>	 <p>MTFT-V840WH</p>	<p>MTFT-V850 Reflector w/ Frosted 3.5" Center Hole in Drop Lens 70W TTT White Metal Trim Ring O.D. : 9-7/16" Height : 7-7/8"</p>  <p>MTFT-V850SM</p>
<p>MTFT-V829 Reflector w/ Cross Louver Blade 42W TTT White Plastic Trim Ring O.D. : 9-7/16" Height : 7-7/8"</p>	 <p>MTFT-V829SM</p>	<p>MTFT-V839 Reflector w/ Frosted Lens on Surface 42W TTT White Plastic Trim Ring O.D. : 9-7/16" Height : 7-1/8"</p>  <p>MTFT-V839SM</p>	

ORDERING DATA

EXAMPLE: CLRFWHWH

Reflector		Lens		Baffle		Metal Ring	
CL	Clear	FR	Fresnel	WH	White	WH	White
WH	White	AS	All Sanded	BK	Black	BK	Black
GD	Gold	CL	Clear	SN	Satin Nickel	SN	Satin Nickel
MA	Matte Platinum	CV	Convex	AN	Antique Nickel	AN	Antique Nickel
CP	Champagne		Prismatic	AC	Antique Copper	AC	Antique Copper
PR	Pewter			MO	Mocha	MO	Mocha
SM	Semi-Matte			CA	Cappuccino	CA	Cappuccino
	Clear			CH	Chrome	CH	Chrome
				UN	Natural Steel	UN	Natural Steel
				PB	Polished Brass	PB	Polished Brass

Dimensions and specifications subject to change without notice.

DIMENSIONS

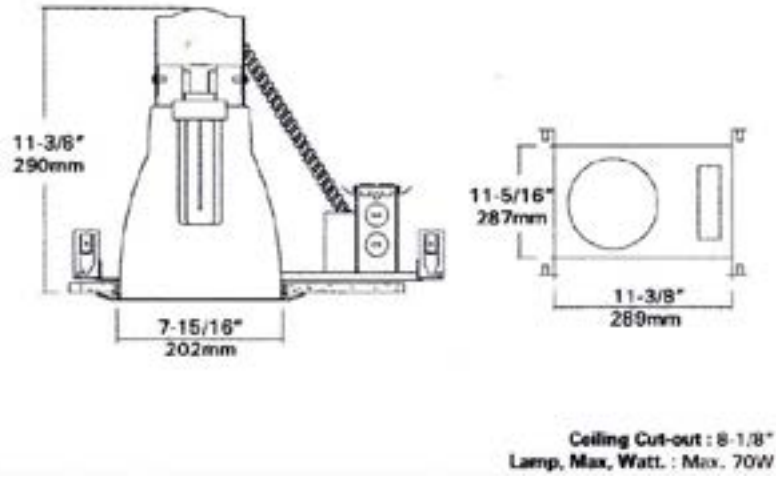

Dimensions and specifications subject to change without notice.

CAT#			
JOB NAME		TYPE	