

APPLICATIONS

A linear 2x3 fixture for distinctive architectural lighting plans. Ideal for corridors, lobbies and office areas, 2x3 Series fixtures can be installed individually or in a continuous run. Specifically designed for direct/indirect lighting with snap-in lens to hide the LED arrays. Ideal where downlight and uplight are required.



FEATURES & BENEFITS

- ◆ Available in custom finishes (consult factory)
- ◆ Fixtures can be surface mounted to the wall or ceiling or pendant hung by engineered hanging kit
- ◆ $c_{ETL_{US}}$ listed for damp locations up to 90 watts
- ◆ $L_{70} > 50000$ hrs.
- ◆ Min CRI 80
- ◆ 5 year warranty

ORDERING DATA

EXAMPLE: L23PMW48LED45DMVWH40

Series		Length	Gear	LED Module Distribution		Finish ²	Color Temp	Configuration	
L23W	Wall Mount	24 24 inch	LED	Blank	Downlight (std)	WH White	30 3000K	Blank	Individual
L23P	Pendant Mount	48 48 inch		1U2D	Uplight & Downlight	BK Black	35 3500K	-B	Beginner
L23S'	Surface Mount	96 96 inch				SI Silver	40 4000K	-E	End
							50 5000K	-J	Joiner

Lens Material		Wattage & Lumen		Driver & Voltage	
SF	Snap-in frosted acrylic lens			DMV	120-277V Multivolt 0-10V Dimmable
		Down Light		SDMV	Step dimming Multivolt
		<u>24 in.</u>		D347V	347VAC 0-10V Dimming
		13	13 Watts 1300 Lumens	D120	Triac Dimming 120VAC
		19	19 Watts 1900 Lumens	D277	Triac Dimming 277VAC
		23	23 Watts 2300 Lumens		
		<u>48 in.</u>			
		26	26 Watts 2600 Lumens		
		38	38 Watts 3800 Lumens		
		45	45 Watts 4500 Lumens		
		<u>96 in.</u>			
		52	52 Watts 5200 Lumens		
		76	76 Watts 7600 Lumens		
		90	90 Watts 9000 Lumens		
		<u>1 Up & 2 Down Only</u>			
		<u>24 in.</u>			
		18	18 Watts 600U-1200D		
		27	27 Watts 900U-1800D		
		<u>48 in.</u>			
		36	36 Watts 1200U-2400D		
		54	54 Watts 1800U-3600D		
		<u>96 in.</u>			
		72	72 Watts 2400U-4800D		
		108	108 Watts 3600U-7200D		

ACCESSORIES

- A-HCPF606WH** Pendant mount 5 wire power feed canopy kit, 6' cable with white canopy
- A-HCPF612WH** Pendant mount 5 wire power feed canopy kit, 12' cable with white canopy
- A-HCNPF606WH** Pendant mount non-power canopy kit, 6' cable with white canopy
- A-HCNPF612WH** Pendant mount non-power canopy kit, 12' cable with white canopy

Options

- SS** Integral Occupancy Sensor (adds ~3" to fixture length)
- H6W5** HC606 cable kit with 6' cable & 5 wire power feed/cable incl. & white canopy³
- H12W5** HC612 cable kit with 12' cable & 5 wire power feed/cable incl. & white canopy³
- 2SCS24WH** Two stem kits with 24" stem, canopy, and mounting hardware for a 4' fixture
- Plug in Options**
- PI1** 3 wire harness, including white, black and green
- PI2** 4 wire harness, including white, black, green and blue for emergency backup
- PI3D** 5 wire harness, including white, black, green, violet and gray

Cable Kit Includes:

- 1 - power feed kit w/ 6' or 12', 5 wire power cable w/ clear cord, white canopy, and mounting kit
- 1 - non-power feed kit w/ 6' or 12' non-powerfeed cable w/ clear cord, white canopy, and mounting kit

Notes:

- ¹Downlight only
- ²Consult for custom finish options
- ³Replace "W" with "B" for black canopy. Consult for more color options.
- ⁴See L23R-L23RF-L23RR-LED and L23R-LED spec sheet for matching recessed fixtures



Dimensions and specifications subject to change without notice.

◆ 800-444-WATT ◆ www.mobern.com ◆
8200 Stayton Dr., Ste. 500, Jessup, MD 20794

CAT#	
JOB NAME	
TYPE	

DIMENSIONS

2 ft. - Back View

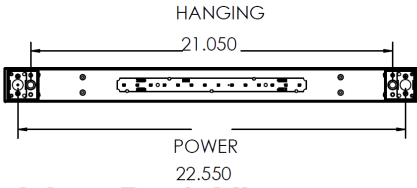

4 ft. - Back View

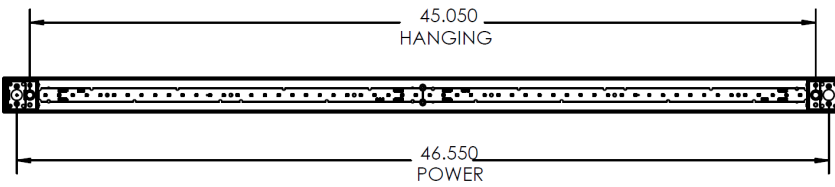

8 ft. - Back View

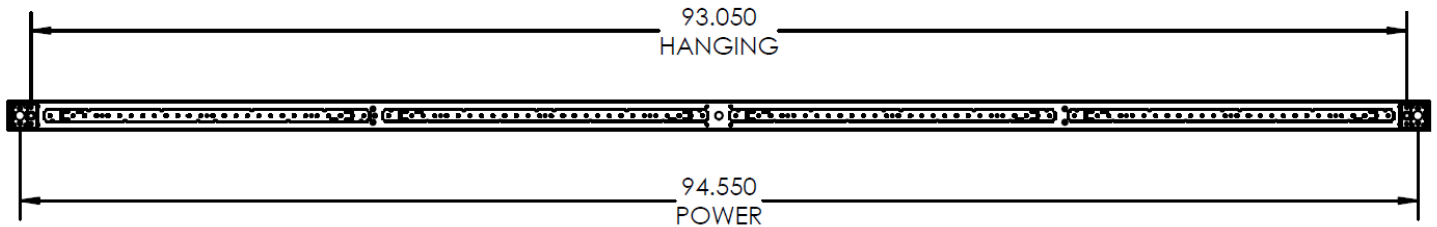

End View

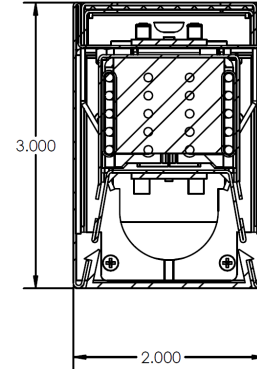

OCCUPANCY SENSOR

- ◆ Push-button programmable adjustable time delays
- ◆ No field calibration or sensitivity adjustments required
- ◆ Convenient test mode
- ◆ Green LED indicator
- ◆ Adds ~3" to fixture length



SENSOR BOX DRAWINGS & DIMENSIONS

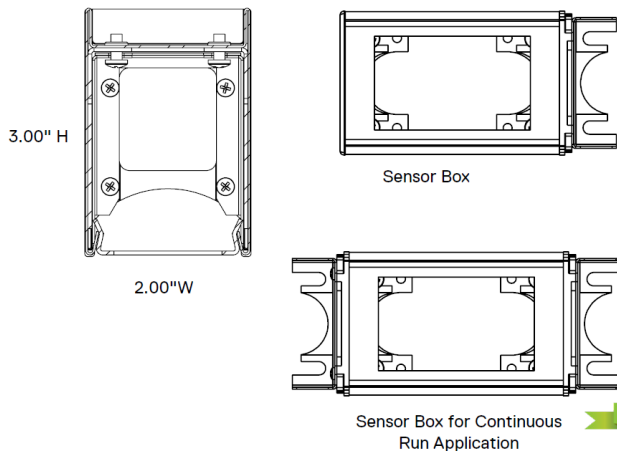

UNIVERSAL 360° LENS

- Provides excellent detection of large motion (e.g. walking) when mounted between 15 to 40 ft (4.57 to 12.19 m)
- 15 to 20 ft (4.57 to 6.10 m) radial coverage overlaps area lit by a typical high bay fixture
- Recommended for fixtures that have a 1:1 spacing to mounting height ratio or less (e.g. fixtures 30' on center or less @ a 30' mounting height).

SIDE VIEW

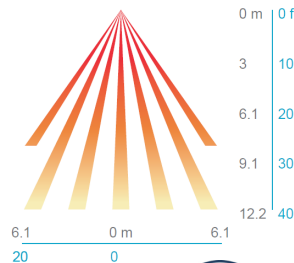

TOP VIEW

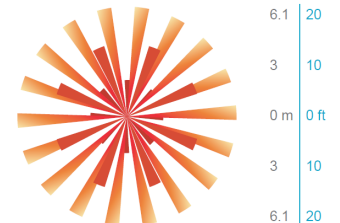

Dimensions and specifications subject to change without notice.

◆ 800-444-WATT ◆ www.mobern.com ◆

8200 Stayton Dr., Ste. 500, Jessup, MD 20794

CAT#

JOB NAME

TYPE